

# SIGRAFLEX®

## Flexible graphite foils and sheets for high temperature applications (US units)

SIGRAFLEX products manufactured from expanded natural graphite improve the performance of systems and processes in high temperature applications, minimize energy consumption and guarantee reliability.

SIGRAFLEX flexible graphite foils are free of adhesives and binders. Demonstrating its extraordinary properties, it can be used in ultra high temperature applications ranging up to 5400 °F in inert atmosphere or vacuum. Superior thermal and electrical conductivity makes it a suitable material for a wide range of parts and components in heat treatment furnaces, poly crystalline silicon and semiconductor, solar and other ceramic production equipment. It can be provided in high purity and ultra high purity to prevent product contamination. SIGRAFLEX is often used in combination with SGRATHERM® soft and rigid felts, SIGRABOND® carbon fiber reinforced carbon and SIGRAFINE® synthetic graphite.

### Properties

- Soft and flexible, inert, highly impermeable
- Light weight, simple machining, cutting and punching
- Thermal dissipation, electrically conductive, no static charges
- Excellent chemical resistance
- High purity
- No aging
- No wetting by glass, ceramic or metal melts
- Sheets are available with pinholes for outgassing

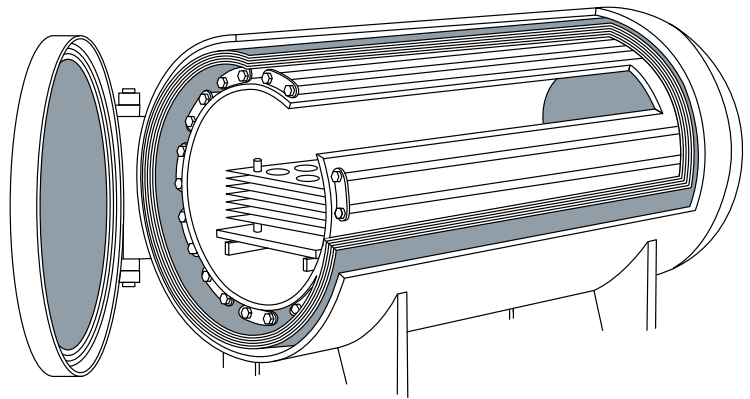

↑ Heat shields – SIGRAFLEX flexible graphite foils and sheets are used as a reflective shield against thermal radiation. Its anisotropic character enhances thermal dissipation and even heat distribution throughout the furnace hot zones.



← Protective liners and diffusion barriers – Off-gas from production parts can build up undesired deposits and dendrites or could corrode or oxidize graphite furnace parts. SIGRAFLEX is used as a protective liner on carbon and graphite components like rigid felt resulting in a longer service life.

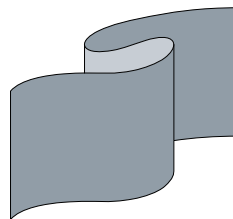

← Release liners – A low friction coefficient, being bendable and thermally conductive makes SIGRAFLEX a perfect material for this application. These properties allow high efficiencies and short turnaround times.

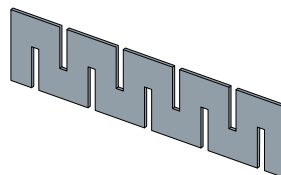

← Heating elements – SIGRAFLEX can also be used as a material to make low cost heating elements, providing a uniform temperature profile. Its low thickness enables short heat-up and cooling cycles.

## Material data of SIGRAFLEX® flexible graphite foils and sheets

Typical properties	Units	TH	NH	THP	S	HP	UHP
Standard density	lb/ft <sup>3</sup>	44/62/75/81	44/62/75/81	62	70	70	70
Ash content [ASTM C561]	%	≤ 0.15	≤ 0.4	≤ 5 or 10 ppm*	≤ 1.0	≤ 0.20	≤ 200 ppm
Carbon content [ASTM D5373]	%	≥ 99.85	≥ 99.6	≥ 99.999 or 99.9995*	≥ 99.0	≥ 99.8	≥ 99.98
Material thickness (supplied as sheets)	in	0.039/0.059 0.079/0.118	0.039/0.059 0.079/0.118		0.030/0.060 0.120	0.030/0.060 0.120	0.030/0.060 0.120
Material thickness (supplied on rolls)	in	0.006/0.008/0.01 0.014/0.02 0.031/0.039	0.006/0.008/0.01 0.014/0.02 0.031/0.039	0.01/0.014 0.02/0.03	0.010/0.020 0.030/0.060	0.010/0.020 0.030/0.060	0.010/0.020 0.030/0.060
Roll width	in	19.7/39.4	19.7/39.4	19.7/39.4	20/30/60	20/30/60	up to 2
Standard roll length	ft	164	164	164	316	316	100
Sheet sizes	in	19.7 x 39.4 39.4 x 39.4 up to 59.1 x 98.4	19.7 x 39.4 39.4 x 39.4 up to 59.1 x 98.4	19.7 x 39.4 39.4 x 39.4	up to 60 x 60	up to 60 x 60	up to 60 x 60
Availability		EU grade	EU grade	EU grade	US grade	US grade	US grade

\* Ash content ≤ 10 ppm and carbon content ≥ 99.999 % is standard, ≤ 5 ppm and ≥ 99.9995 % on request

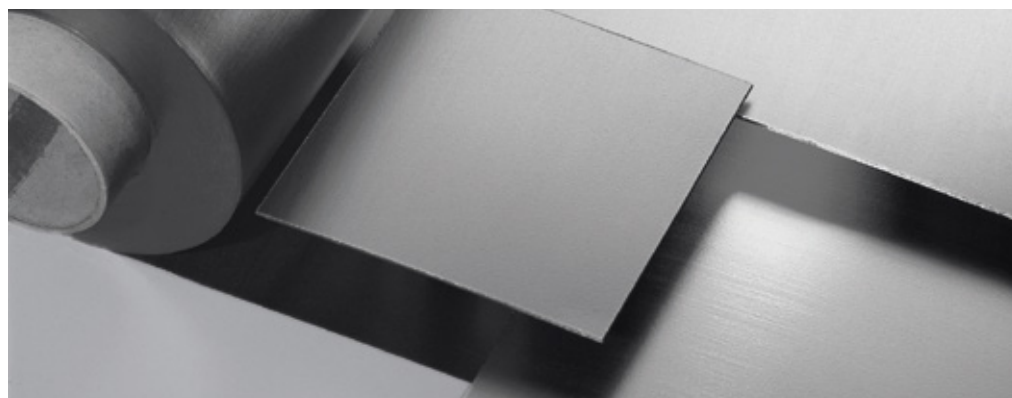

↑ SIGRAFLEX foils and sheets made from expanded natural graphite

### Common grades of SIGRAFLEX® flexible graphite

Homogenous	TH, NH, HP, S
Postpurified	THP, UHP

## Material data of SIGRAFLEX® HP with a density of 70 lb/ft<sup>3</sup>

Typical properties	Units	Values
Sublimation temperature	°F	> 5400
Temperature resistance	in air in inert gas and vacuum	approx. 750 approx. 5400
Specific electrical resistivity [70 °F]	parallel to surface perpendicular to surface	10 750
Thermal conductivity [70 °F]	parallel to surface perpendicular to surface	250 5
Specific heat capacity [70 °F]		kJ/Kkg
Thermal expansion coefficient [70 – 1800 °F]	parallel to surface perpendicular to surface	approx. 1 approx. 50
Shore hardness (D)		30
Elongation at break	%	≥ 1
Tensile strength [ASTM F152]	psi	≥ 500
Permeability coefficient for air	perpendicular to surface	cm <sup>2</sup> /s
Coefficient of emission [2732 °F]		0.65
Ash content [ASTM C561]	%	approx. 0.1

Other values or dimensions on request

Unless stated otherwise, all values are valid at room temperature, typical, non-binding and subject to change. For engineering or design purposes please contact our technical sales team.

**Thermal conductivity of SIGRAFLEX with density 70 lbs/ft<sup>3</sup> parallel to surface as a function of temperature**

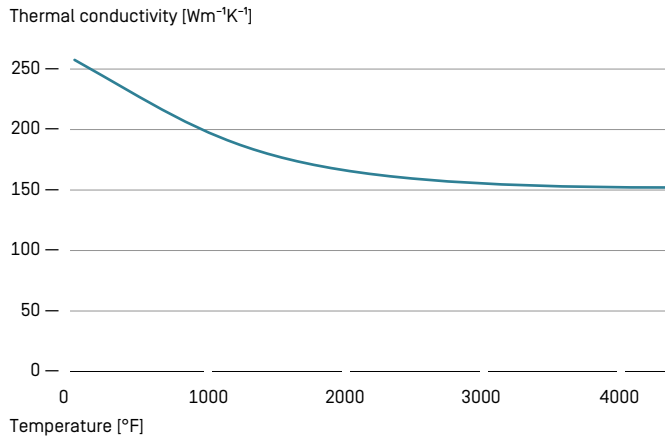

**Thermal conductivity of SIGRAFLEX with density 70 lbs/ft<sup>3</sup> perpendicular to surface as a function of temperature**

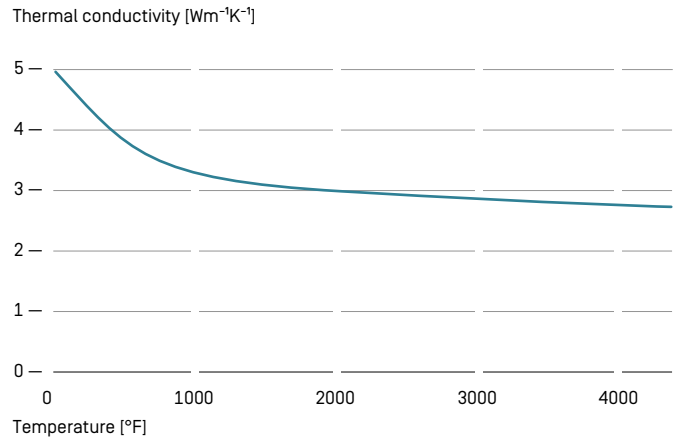

**Thermal conductivity of SIGRAFLEX parallel to surface at room temperature as a function of density**

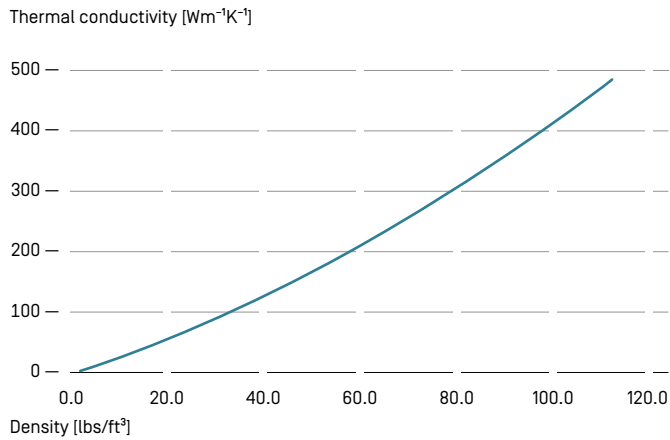

**Thermal conductivity of SIGRAFLEX perpendicular to surface at room temperature as a function of density**

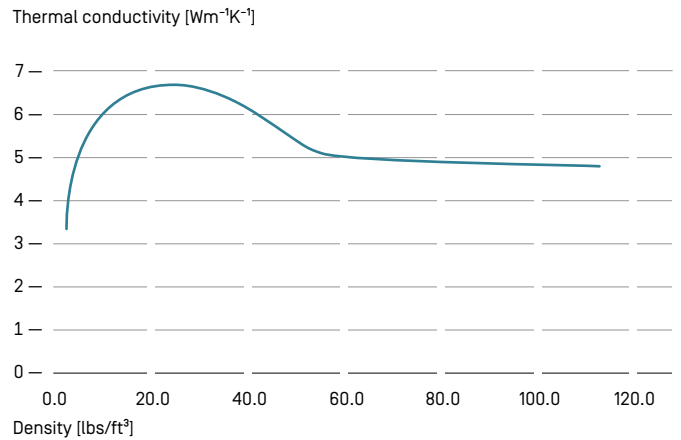

**Specific electrical resistivity of SIGRAFLEX parallel to surface at room temperature as a function of density**

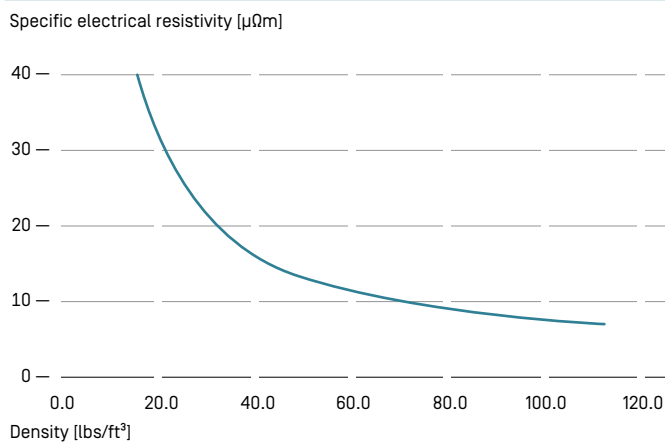

**Specific electrical resistivity of SIGRAFLEX with density 70 lbs/ft<sup>3</sup> parallel to surface as a function of temperature**

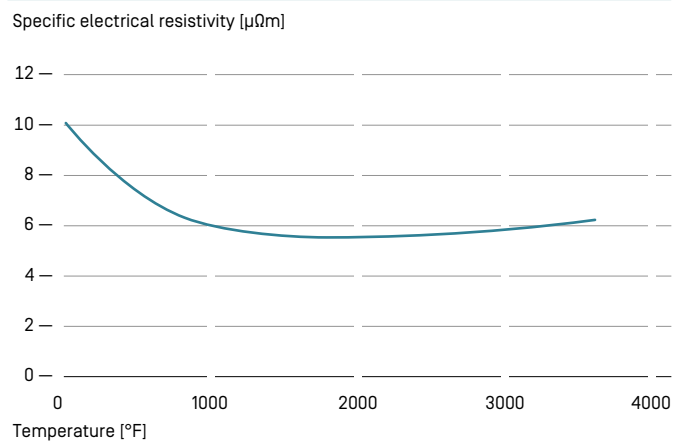

## Total emission coefficient of SIGRAFLEX with density 70 lbs/ft<sup>3</sup> as a function of temperature

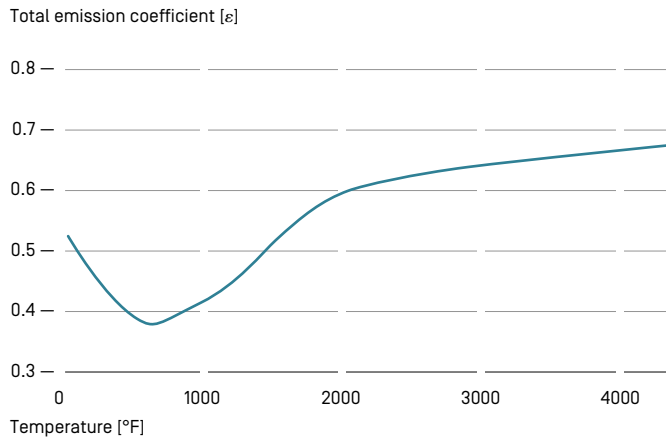

**Graphite Solutions | SGL CARBON GmbH | SGL Technic LLC**  
Sales Europe/Middle East/Africa | [sigraflex-europe@sglcarbon.com](mailto:sigraflex-europe@sglcarbon.com)  
Sales Americas | [sigraflex-americas@sglcarbon.com](mailto:sigraflex-americas@sglcarbon.com)  
Sales Asia/Pacific | [sigraflex-asia@sglcarbon.com](mailto:sigraflex-asia@sglcarbon.com)  
[www.sigraflex.com](http://www.sigraflex.com) | [www.sglcarbon.com](http://www.sglcarbon.com)

**TDS TH\_NH\_THP\_S\_HP\_UHP\_Foil\_US.03**

03 2021/0 2NÄ Printed in Germany

®registered trademarks of SGL Carbon SE

This information is based on our present state of knowledge and is intended to provide general notes on our products and their uses. It should therefore not be construed as guaranteeing specific properties of the products described or their suitability for a particular application. Any existing industrial property rights must be observed. The quality of our products is guaranteed under our "General Conditions of Sale".